



RELIABILITY BUILT IN™

T&S Waste Valves

*Making Foodservice Clean-up
Easier Than Ever*



**NEW and
IMPROVED!**

Introducing
**Our NEW Line of Stainless Steel
Modular Waste Valves**



Introducing... T&S Premium Stainless Steel Modular Waste Valves



B-3992
(shown closed)

B-3992
(shown open)

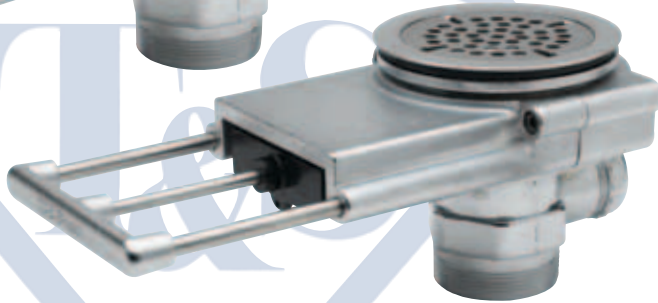

B-3992-5X
(with handle extensions;
shown closed)

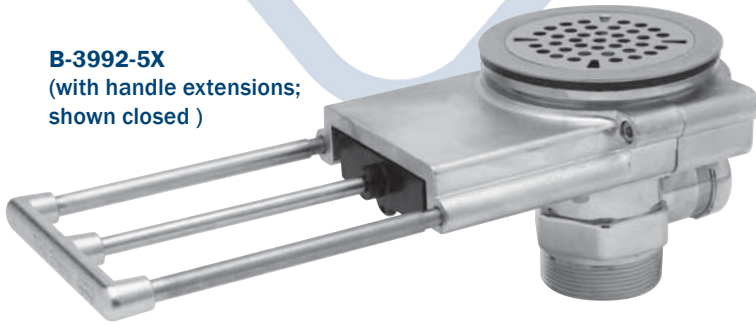

T&S Brass is proud to introduce our new series of premium **Stainless Steel Modular Waste Valves** with 18 models available to fit almost any sink specification you may have. These patent-pending valves offer superior features over comparable rotary ball valves for 3½" sink openings. Their rugged design and stainless steel construction keeps performing when other valves fail.

Like our other waste valves, the Stainless Steel Modular Waste Valves are available both with and without overflow assemblies. Designed to excel in the most demanding applications, they exceed our strict quality and reliability standards.

Features include:

- Modular design for easy installation and maintenance
- Stainless steel construction including valve and upper and lower castings
- Large drain opening to accommodate high-volume applications
- Push-pull valve activation with rugged handle to endure the most extreme abuse
- Continual leak-free service
- Unique installation tool comes with every Stainless Steel Modular Waste Valve (#017670-45) making installation easy
- Handle extension kits available
- Limited lifetime warranty*

B-3990 Series Stainless Steel Modular Waste Valves

- For 3½" Sink Opening
- 2" NPT Female x 1½" NPT Male Adapter
- -01 Models include Overflow Tube with Head Assembly

B-3992 Series Stainless Steel Modular Waste Valves

- For 3½" Sink Opening
- 2" NPT Male x 1½" NPT Female Outlet
- -01 Models include Overflow Tube with Head Assembly

Overflow Tube with Head Assembly (-01)

- An option for both B-3990 and B-3992 Modular Waste Valves, or
- Order **B-3999-OF** (if ordered separately)

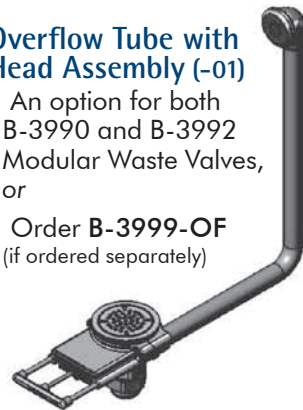

Handle Extension Kits

B-3990-3KIT

- Includes three (3) 3" extension rods and a capsule of Loctite 222
- Extends Modular Waste Valve handles by 3"

B-3990-5KIT

- Includes three (3) 5" extension rods and a capsule of Loctite 222
- Extends Modular Waste Valve handles by 5"

Waste Valve Installation Tool

(Part #017670-45):

- Included with all Modular Waste Valves
- Helps with installation of any 3" and 3½" drains on the market
- Can be ordered separately

* Covers all components except wearable items such as upper and lower seals and valve assembly

Models:

- B-3990**
- B-3990-BSP**
- B-3990-3X**
- B-3990-5X**
- B-3990-BSP-3X**
- B-3990-BSP-5X**

- B-3990-01**
- B-3990-01-BSP**
- B-3990-01-3X**
- B-3990-01-5X**
- B-3990-01-BSP3X**
- B-3990-01-BSP5X**

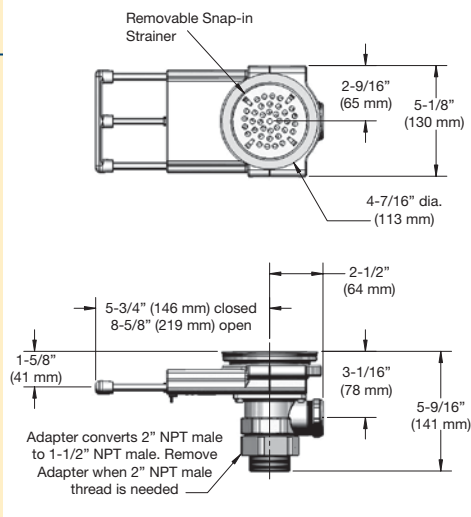

- 01** Includes Overflow Tube with Head Assembly
- 3X** Includes 3" Handle Extension Kit
- 5X** Includes 5" Handle Extension Kit
- BSP** With 1/2" BSP male adapter

Models:

- B-3992**
- B-3992-3X**
- B-3992-5X**

- B-3992-01**
- B-3992-01-3X**
- B-3992-01-5X**

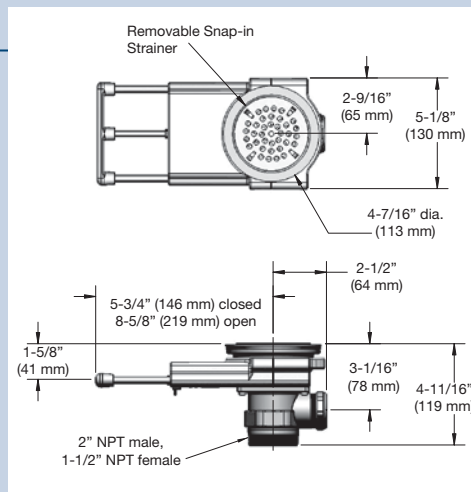

How Do I Decide What Length Handle Extensions I Need For My Modular Waste Valve?

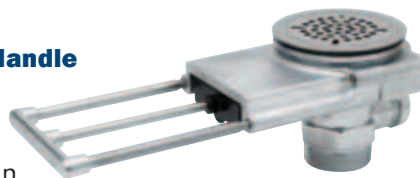

All our Modular Waste Valves can be modified with 3" or 5" handle extensions to accommodate your sink measurements and preferences. Refer to the chart below for *optional* or *recommended* use of handle extensions.

Sink Bowl Length (Front to back measurement of Sink Bottom)	3" Handle Extension	5" Handle Extension
18"	Optional (not needed)	Optional (not needed)
20"	Recommended	Optional (not needed)
24"	Recommended	Optional (not needed)
28"	Not recommended	Recommended

How Do I Select A Modular Waste Valve?

Your sink bowl length is the determining measurement. These illustrations show which of the *recommended* handle extension kits can be selected based on four common sink bowl lengths.

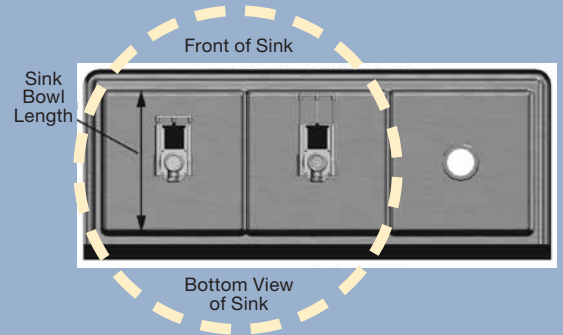

18" Sink Length with NO Handle Extension

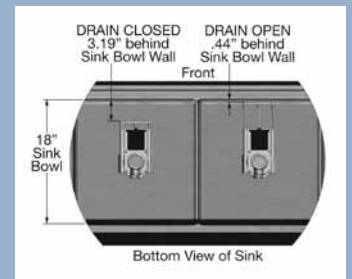

20" Sink Length with 3" Handle Extension

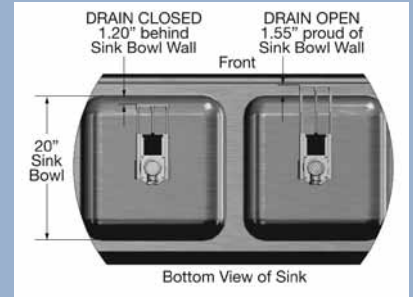

24" Sink Length with 3" Handle Extension

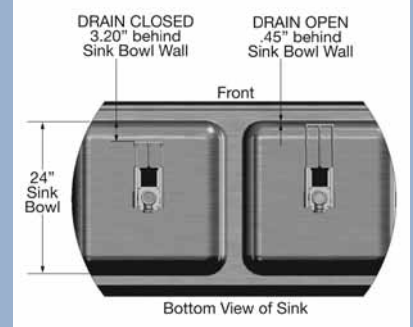

28" Sink Length with 5" Handle Extension

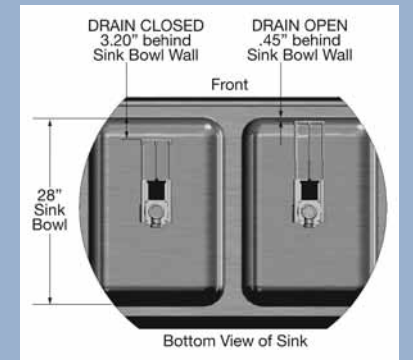



T&S Twist and Lever Waste Valves



**B-3940
Twist Waste Valve**

**B-3960
Lever Waste Valve**

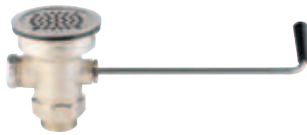

Twist Models

Model	Sink Opening	Drain Outlet	O-Flow Assembly
B-3940	3"	1½" or 2"	Optional
B-3940-01*	3"	1½" or 2"	Included
B-3942	3"	2"	Optional
B-3942-01*	3"	2"	Included
B-3950	3½"	1½" or 2"	Optional
B-3950-01*	3½"	1½" or 2"	Included
B-3952	3½"	2"	Optional
B-3952-01*	3½"	2"	Included

* "-01" models include an overflow assembly

We also offer our popular **Twist and Lever Brass Waste Valves** with 16 models available to fit two different outlet sizes. Our standard Waste Valves are built to last, and are used to the challenges of a commercial kitchen setting.

Features include:

- Overflow outlet and cap
- Brass valve body construction
- Valve bodies come standard with a 2" outlet
- 3" (76 mm) or 3½" (89 mm) sink opening applications
- -01 models come furnished with a complete overflow assembly
- Some models are available with a conversion adapter that reduces a 2" drain outlet to a 1½" outlet
- Master Packs (12) are available
- 1-year warranty

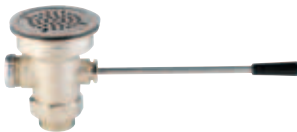

Lever Models

Model	Sink Opening	Drain Outlet	O-Flow Assembly
B-3960	3"	1½" or 2"	Optional
B-3960-01*	3"	1½" or 2"	Included
B-3962	3"	2"	Optional
B-3962-01*	3"	2"	Included
B-3970	3½"	1½" or 2"	Optional
B-3970-01*	3½"	1½" or 2"	Included
B-3972	3½"	2"	Optional
B-3972-01*	3½"	2"	Included

* "-01" models include an overflow assembly

Twist and Lever Waste Valve Accessories/Options

Basket Strainer (#010387-45)

Available on all 3½" models as a modification. Also available:

3" Flat Strainer (#010385-45)

3½" Flat Strainer (#010386-45)

-01 Overflow Assembly

Available on all twist and waste valve models;

Ex.: *B-3940-01* Includes Tube (#011355-45) and Head (#011356-45)

NEW! Twist Short Handle (#010393-45XS)

Designed for use on 12" sinks; order handle separately or modify new valve.

Ex.: *"B-3940 modified with 010393-45XS"*

NEW! Lever Short Handle (#010394-45XS)

Designed for use on 12" sinks; order handle separately or modify new valve.

Ex.: *"B-3940 modified with 010394-45XS"*

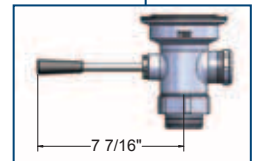
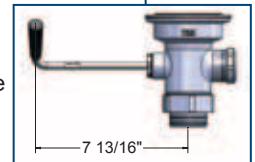

www.tsbrass.com

T&S Brass and Bronze Works, Inc.

2 Saddleback Cove • P.O. Box 1088 • Travelers Rest, SC 29690

Phone (800) 476-4103 • Fax (800) 868-0084

E-mail: tsbrass@tsbrass.com